



**HAL**  
open science

## Autonomous system for data collection: Location and mapping issues in post-disaster environment

Tullio Joseph Tanzi, Jean Isnard

### ► To cite this version:

Tullio Joseph Tanzi, Jean Isnard. Autonomous system for data collection: Location and mapping issues in post-disaster environment. Comptes Rendus. Physique, 2019, 20, pp.204-217. hal-02364491

HAL Id: hal-02364491

<https://telecom-paris.hal.science/hal-02364491v1>

Submitted on 25 Oct 2021

**HAL** is a multi-disciplinary open access archive for the deposit and dissemination of scientific research documents, whether they are published or not. The documents may come from teaching and research institutions in France or abroad, or from public or private research centers.

L'archive ouverte pluridisciplinaire **HAL**, est destinée au dépôt et à la diffusion de documents scientifiques de niveau recherche, publiés ou non, émanant des établissements d'enseignement et de recherche français ou étrangers, des laboratoires publics ou privés.



Distributed under a Creative Commons Attribution - NonCommercial 4.0 International License

Autonomous system for data collection: location and Mapping issues in  
post-disaster environment /  
Système autonome orienté données : localisation et cartographie locale en  
situation post-catastrophe

## Autonomous system for data collection: location and Mapping issues in post-disaster environment

Tullio Joseph Tanzi<sup>a</sup> and Jean Isnard<sup>b</sup>,

<sup>a</sup>Institut Mines Télécom, Télécom ParisTech, LTCI, Paris, France

<sup>b</sup>URSI France, Paris, France

---

**Abstract:** *Disaster relief requires many resources. Depending on the circumstances of each event, it is important to rapidly choose the suitable means to respond to the emergency intervention. A brief review of the conditions and means showed the usefulness of an autonomous stand-alone machine for these missions. If many techniques and technologies exist, their relevant combination to achieve such a system presents several challenges. This communication tries to outline the possible achievement of an autonomous vehicle under these particular circumstances. The paper focus on the specific working conditions and welcomes future contributions from robotics and artificial intelligence.*

*In the necessarily limited scope of this article, the authors focus on a particularly critical aspect: location. Indeed, this machine is intended to evolve in heterogeneous and dangerous environment and without any outside contacts which could last up to several days. This blackout, due to the propagation difficulties of electromagnetic waves in the ground, induces an independence of the localisation process and makes the use of any radio navigation support system (GNSS), most of the time, impossible. The knowledge of the position of the system both, for navigation of the autonomous system (Rover) and location of targets (victims buried under debris) must be able to be estimated without contributions from external systems. Inertial classical techniques, odometer, etc., have to be adapted to these conditions during a long period without external support. These techniques also have to take into account that energy optimisation requests the use of low power processors. Consequently only poor computing capacity is available on-board.*

*The article starts with a presentation of the context of a post-disaster situation as well as the main missions of Search and Rescue (SaR). It is followed by the analysis of autonomous navigation located in a post-earthquake situation. We will then discuss means to determine the attitude of the autonomous system and its position. The interest of hybridization with external systems -- whenever possible --, will be evaluated in view to correct deviations suffered by the system during its mission. Finally prospects and future work are presented.*

**Résumé :** *De nombreux moyens sont mis en œuvre par les secours lors d'une catastrophe. En fonction des conditions propres à chaque événement il faut rapidement faire un choix adapté des moyens disponibles capables de faciliter la mise en œuvre des secours. Une brève revue des conditions et des moyens fait apparaître tout l'intérêt de l'utilisation d'un engin autonome pour ces missions. Si de nombreuses techniques et technologies existent, leur combinaison pertinente en vue de réaliser un tel système présente plusieurs difficultés. C'est l'objet de notre communication dans laquelle on essaie d'esquisser ce que pourrait être un engin autonome aux performances souhaitées en mettant l'accent sur les conditions particulières de mise en œuvre sans préjuger des apports bienvenus de la robotique et de l'intelligence artificielle.*

*Dans le cadre forcément limité de cet article, parmi la longue liste de difficultés à surmonter, nous nous focaliserons sur un point particulier qui se révèle critique : la localisation. En effet, cet engin est destiné à évoluer en milieu hétérogène et dangereux et sans contacts durant des périodes assez longues, de l'ordre de plusieurs jours. Ce blackout radio, dû aux difficultés de propagation des ondes électromagnétiques dans le sol, induit une indépendance du processus de localisation et interdit, du moins la majorité du temps, le recours à des aides de radio navigation tel que par exemple le GNSS. La connaissance de la position de système autonome (Rover), nécessaire à la fois à la navigation et à la localisation des cibles (victimes enfouies sous les décombres) doit donc pouvoir être estimée sans contributions de systèmes externes. Les techniques classiques inertielles, d'odométrie, etc., devront donc être adaptées à ces conditions particulières afin de fonctionner de manière précise durant une longue période sans aide. Elles devront aussi être adaptées pour tenir compte du fait que le bilan énergétique restreint à une utilisation de processeur de faible puissance et donc de faible vitesse et capacité de calcul.*

*Nous commencerons notre texte par présenter le contexte particulier d'une station post-catastrophe ainsi que les principales missions de Search and Rescue (SaR). Suit ensuite la problématique de navigation autonome contextualisée à une situation post-séisme. Nous aborderons ensuite la détermination de l'attitude de l'engin et sa position suivi de l'intérêt d'une hybridation avec des systèmes externes, lorsque cela est possible, afin corriger les dérives subies par l'engin au fil de sa mission. Nous concluons*

*sur des perspectives et des travaux futurs.*

**Keywords:** *Embedded Sensors, Autonomous system, Real-Time*  
**Mots-clés :** *Capteurs embarqués, système autonome, temps réel.*

## 1. Introduction

When a natural disaster occurs in a populated area, it is necessary to organise quickly and efficiently disaster management operations to assist the population, to reduce the number of victims and to mitigate the economic consequences [1-3]. Emergency management starts with the search and rescue and continues with the stabilisation of the overall situation of the disaster. At every moment, rescue teams have immediate information need [4] about the situations they face: evolution of the situation, identification of the survivors, critical areas, access to the refugees, support tools, and so on. As explained in [2], the use of new technologies and new approaches are needed for a more effective risk management, before, during and after a crisis. Each action, specific to each step of the crisis, must be taken into account. For this purpose, new tools and methodologies are needed to better manage these situations. Information therefore plays a key role in the management of natural or man-made catastrophes and in the organisation of relief.

The theatre of this type of event is a dangerous area, including for rescue teams. Therefore, it is important to get information about conditions on this area. Use of autonomous systems, such as "robots", for the acquisition of information to facilitate relief operations, reduces the exposure of the intervention teams on the ground. Using systems adapted and configured according to the type of disaster thus gives access to inaccessible locations to humans because of their geometry (fault, hole, and so on.) or danger (unstable area, scree, and so on).



Fig. 1. Conditions in post-catastrophe area

### 1.1 *Autonomous system applied to disaster management*

In such a worst-case scenario, autonomous systems can perform many tasks to facilitate relief efforts. These tasks may include communications, exploration of the area or still searching for survivors. It is difficult to maintain permanent communications on a disaster area. The public communication network may be unavailable, damaged or destroyed. However, the coordination of relief efforts requires communication. To overcome this, autonomous systems can be deployed to build temporary mobile access points to extend communications to the affected area [5].

Another important task, that can be performed independently, is the creation of high resolution maps in the affected area. Disasters can radically alter the concerned region, which introduced significant changes in the maps already available. For example, drones can fly over the region with 3D cameras coupled with GNSS and automatically create 3D maps up to date in the area [6, 7]. These maps can be used to understand the impact of the disaster on the zone and, for example, decide which roads are to be closed, find the best way to reach the most affected areas or provide for the delivery of relief [8.9]. Autonomous systems can also actively participate in Search and Rescue operations (SaR: Search and Rescue). They can, for example, perform an infrared analysis of the area in order to find victims.

The use of autonomous vehicles incorporating modern technology sensors [10, 11] (LIDAR, Radar, video, and so on) opens new perspectives in this field. These facilities are more efficient ways to acquire information of any kind [4] in order to explore a given environment. The use of sensors coupled to an autonomous system allows to carry out a mission without external intervention. This approach allows to escape constraints of existing infrastructure or difficult communications [12], as is the case of infrastructure down or destroyed. The captured information possesses a dual purpose: on the one hand, understand and model the environment for a successful completion of the mission and on the other, to reuse this modelling in a broader framework of decision-making for the benefit of the relief teams. [13, 14].

The processed data are produced by a set of diverse instruments and deployed in sensors networks for real-time collection [15, 16]. The data produced are of various types: distance data from ultrasonic sensors (time of flight); distance data obtained from optical laser sensors (LIDAR); position and attitude data of inertial systems (accelerometers, gyroscopes and magnetometers, and so on), odometer data; environment data such as temperature, pressure, etc. These data will be combined to measure different elements of the environment.

The implementation of new approaches, such as detection of electromagnetic waves emission from portable devices [17], smartphone and more generally of everything that is part of the Internet of Things (IOT), is a real optimisation of relief (see fig. 2). To this effect specific signals have to be transmitted at short distance in order to activate the above mentioned devices. . Finally, the payload of high-tech sensors, such as Ground Penetrating Radar (GPR), allows the detection of people buried under debris [18, 19].

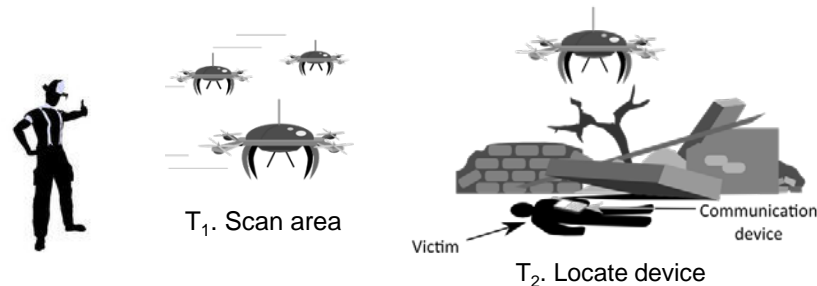

Fig. 2 : SaR Mission example (from [17])

Encountered difficulties lay in both, the system conception and its operational use. They concern the use of low-power processors to save energy, the configuration of critical embarked system and the uncertainty of measured data as well as their protection by means of logical and cryptographic mechanisms [23-25].

### 1.2 Characteristics of intervention area

At present there are many Integrated Navigation Sensing and Communication Systems (INSC) aiming at a) improving the life quality (QoL) of persons as well as their ability to establish various communications and b) increasing the efficiency of different networks within the same frequency bandwidths (26). These applications are based on identical technics already in operation or about to be used. The future contribution of robotics and artificial intelligence will be welcomed taking into account the specificity of the subject.

The present application undoubtedly comes under the general type of INSC systems, although the particular context of their use makes them quite different. On the one hand the scientific data on the environment are lacking and on the other miniaturisation and energy consumption is an essential factor. Of course proven detection, observation and communication techniques exist, but their application to the present case requires to revisit, in detail, their operating principles. Many and various sensors already exist; the main difficulty is to define an optimal combination based on physical properties and on the particular conditions of use

The energy balance is a major difficulty in this context. As a reminder the energy density of batteries using modern technologies, such as LiPo (Lithium polymer), remains of the order of 350 watt hour per kilogram of weight.

An autonomous exploration system implemented in situations of disasters is, as just described, a component whose

objective is to explore dangerous and penetrable spaces with a representative volume of a building or a city block, that is to say approximately  $50 \times 50 \times 30$  is  $75\,000\text{ m}^3$ . Even if the search volume may seem small in the scale of the area impacted by the disaster, the mission of these systems lasts several days. This term has a strong impact in the choice of instrumentation. Therefore, it is necessary to use low-power sensors. It is also necessary to implement a policy for the management of the sensors in order to continuously master the electric energy consumed.

The location also presents many difficulties. The autonomous engine (see fig. 3) is intended to operate in a heterogeneous and dangerous environment and, for the largest part of its mission, in a discontinuous environment or/and unfavourable for the propagation of radio waves [27, 28] (see fig. 4). It is difficult to maintain a continuous radio link or even continue to use conventional radio navigation helps such as GNSS.

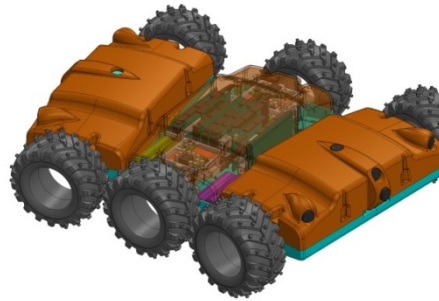

Fig. 3: Module Arcturius: research and detection of buried people after an earthquake

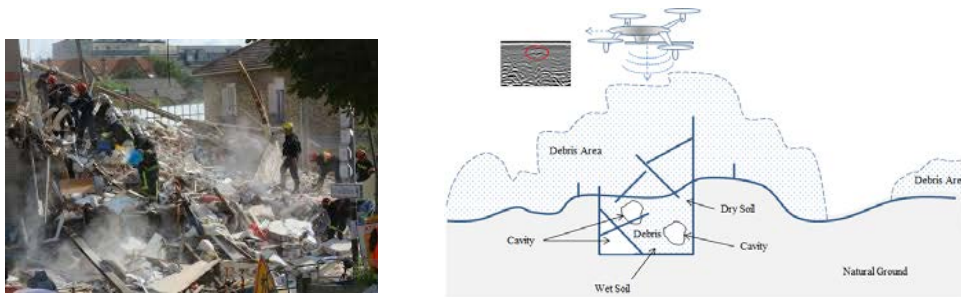

Fig. 4 : Context of intervention (from [27])

In this article, we will present such a system adapted to the post-earthquake interventions. Field scenarios have been developed to facilitate the evaluation of our prototype in an operational context.

## 2. Autonomous navigation of mobile system

Autonomous navigation requires an embedded intelligence. In previous researches, we developed autonomous navigation features for drones based on the following points: (i) the definition and the implementation of the special flight manoeuvres (advanced control), and (ii) the definition and implementation of algorithms for analysis of image in order to reconstruct the 3D environment or to track information, objects or people [29, 30].

In the present context, during exploration the engine has to establish a map by itself for its own navigation, known as SLAM (Simultaneous Localisation and Mapping). SLAM requires a completely autonomous system which may not have a priori information on its environment, and which builds incrementally and automatically a map. The engine has to determine its position gradually from one point to the other and keep track of previous positions. There are cases where no a priori information exists which is the case either at the starts or when an unpredictable earth slide occurs. The latter case is more complicated because data on previous positions are lacking.. When the path contains cycles, loop detection problem arises. Consequently it is difficult to know if the system has returned to the starting point of the loop: ambiguities could further complicate the navigation in particular from the point of view of the sensors.

The literature offers numerous approaches to address these issues, based on the available sensors, real time constraints, conditions of the environment (indoor/outdoor, static/dynamic) and so on. However, we can distinguish

two basically different approaches: the metric approach and the topological approach. The first is committed to providing a meaningful metric location in an absolute reference. The second seeks to produce a qualitative location. Hybrid approaches exist, which combine these two approaches.

### 2.1. Usable technology in the context

It is possible to decompose the displacement of an object according to six independent geometric transformations (translations and rotations around the axes fixed in the three dimensions). There are three translational motions: longitudinal movement ( $T_x$ ) that shows the movements of an object which advances or moves back, the transversal movement ( $T_y$ ) which designates an object that moves from right to left and finally the vertical movement ( $T_z$ ). There are then three movements of rotation: roll ( $R_x$ ) which designates the rocking motion from right to left, the pitch ( $R_y$ ) which marks the movement of rocking from the front to the back and finally yaw ( $R_z$ ) which is the pivot from right to left. Selecting an orthonormal systems of axis ( $O, x, y, z$ ) these six degrees of freedom are expressed in the form below (see fig. 5) where we consider the X-axis as the progression direction, and Z-axis as being the vertical axis. The presentation of the degrees of freedom takes the form of a matrix.

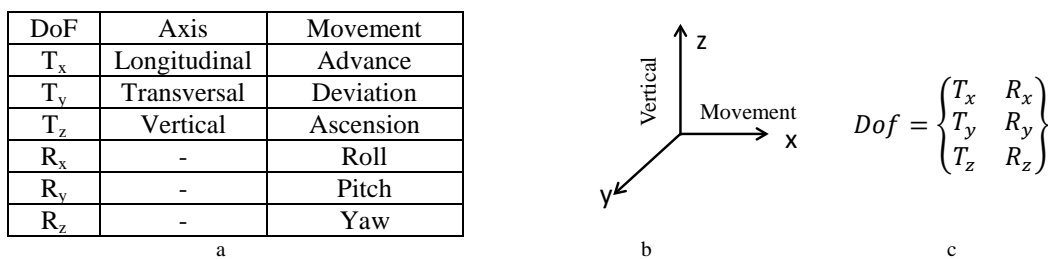

Fig. 5 : Object Degree of Freedom (DoF)

Accelerometers measure the movement of translation and gyroscopes measure the rotation. This combination of sensors is often called an IMU, for "Inertial measurement unit", and it is used, for example, in aircraft, spacecraft, and so on. An axis of a sensor in an IMU corresponds to one DoF (Degrees of Freedom). An integrated circuit with one gyroscope that has 3 axes and one accelerometer with 3 axes also, constitute an IMU 6 – DoF .i.e IMU 6 Degree of Freedom (see fig. 6).

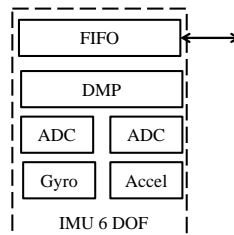

Fig. 6: Inertial Measurement Unit (IMU) 6 DOF

MEMS technology, acronym of Micro Electro Mechanical Systems (Systèmes Micro-Electro-Mécaniques in French), allows to perform miniaturised devices combining several physical principles. MEMS circuits usually integrate mechanical components coupled with sensors and are made by process derived from microelectronics manufacture. These sensors operate effects related to electromagnetism, thermic and fluid technology. They are in our daily lives, in the heart of telephony, automotive, medical, chains of production or the joysticks of game consoles: that is to say that these technologies are already available.

The MEMS sensors have a mobile part which is related to the physical magnitude to be measured [31- 33]. For example the principle of a resonant sensor is based on the oscillation of the mechanical part. The vibration frequency is dependent on the physical quantity to be measured. A variation of this physical quantity leads to a variation of an electric quantity which is returned in the form of a voltage measurement (see fig. 7).

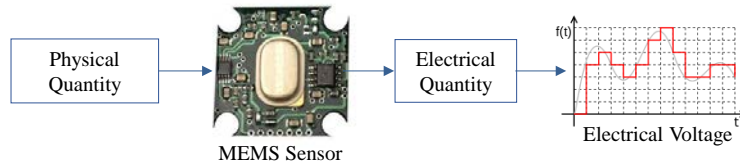

Fig. 7: Measurement principle

## 2.2. Use of MEMS inertial sensors

The principle of measurement is based on amplification of the output signal from the microstructure using a displacement measure (piezo-resistive or capacitive) [34] to re-inject it at the input to generate movement via a micro-actuator (electrostatic or magnetic) integrated in the MEMS circuit. A MEMS circuit can be considered as part of an unstable control loop whose output frequency is defined by the mechanical characteristics of the mobile part. The sensitivity of these systems is inversely proportional to their size. The reduction of the dimensions in the micrometer scale of mobile mechanical structure lead to even higher frequencies of vibration, reason why it is widely used when the accuracy is important.

Acceleration due to gravitational forces and those due to the movements of the autonomous system cause a force of inertia that is detected by the accelerometer. These sensors are relatively accurate, but remain sensitive to noises such as mechanical vibrations for example. Accelerometers provide attitude (angle of inclination according to the different axes) of the autonomous system. Different categories of MEMS accelerometers exist. The most common are based on capacitive or piezoelectric effect [34]. The sensor supplies, for each of the axes  $x$ ,  $y$  and  $z$ , a voltage proportional to the force generated by acceleration [35].

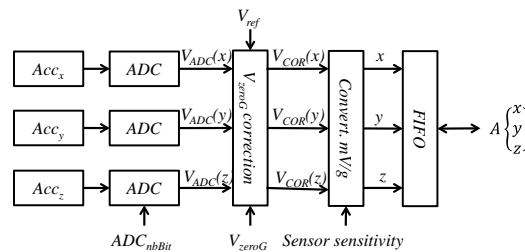

Fig. 8 : Acceleration measuring process

The accelerometer provides, for each axis  $x$ ,  $y$  and  $z$  (see fig. 8), an output in the form of a voltage level in a defined range ( $A \{x, y, z\}$ ). These values must be converted to digital value by the use of an *analog-to-digital* converter (ADC). A value encoded in binary ( $V_{ADC}$ ) is obtained in a range depending on the number of bit of the AD converter  $[0..(2nbBits)-1]$ . The corresponding voltage is then calculated by taking into account the reference voltage ( $V_{ref}$ ) of the converter that is usually the voltage of module power supply.

Each accelerometer has a "zero-g" level of voltage ( $V_{zeroG}$ ), which corresponds to the voltage provided when it is submitted to zero acceleration. This reference 0g allows to calculate the corrected voltage ( $V_{Corr}$ ). This corrected value will allow us to calculate the value of acceleration, expressed in "g" by using the accelerometer sensitivity expressed in  $mV/g$ . The three components  $A \{x, y, z\}$  define the vector of the inertia force  $Fi$ . These various reference values, necessary for the calculations, are available in the specification documentation of the sensor (Sensor DataSheet).

However, the data produced by the accelerometer are not always reliable. There are several reasons for this unreliability; the first is that an accelerometer measures a force of inertia. This force can be caused by gravity, but it also can be caused by acceleration due to the movement of the autonomous system. Accordingly, the accelerometer is still very sensitive to vibration and mechanical disturbances in general. In this context, a gyroscope can be used to smooth the accelerometer errors. The gyroscope is also sensitive to noise, but it measures rotation and it is less sensitive to linear mechanical movements. Gyroscopes have other disadvantages, such as difficulty to go back to the value zero, when the rotation stops. Nevertheless by performing a data fusion between accelerometer data and gyroscope data, we get a better estimate than that calculated using only data provided by the accelerometer.



The gyroscopes MEMS (Vibrating Structure Gyroscopes or VSG) consist of a set of microscopic wings that are continuous in both directions of movement. They use the principle of Coriolis acceleration to detect the rotation rate of change. When the gyroscope is rotating, it resists at the change of direction due to the conservation of angular momentum. Meanwhile, the piezoelectric crystals produce a current proportional to the angular velocity [36].

The gyroscope measures the rate of change of angles, i.e. angular speeds. It produces a value that is in linear relationship with the rate of change of these angles. We define the measure of angle of rotation around the Y axis, i.e. the  $A_{xz}$  angle, at time  $t_0$ , as being equal to  $A_{xz}(0)$ . The measurement of this angle at the time  $t_1$  is defined as being equal to  $A_{xz}(1)$ . The angular speed  $V$  is calculated by  $V(A_{xz})$ .

$$V(A_{xz}) = \frac{(A_{xz})_1 - (A_{xz})_0}{t_1 - t_0}$$

As for all data produced by the accelerometer (see above), you get a raw value which must be processed.

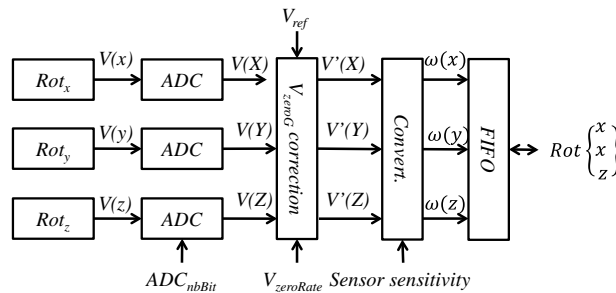

Fig. 9: Rotation measuring system process

The sign of this value determines the direction of rotation defined in the specifications of the gyroscope. The chain of calculation is similar to that implemented for the processing of the accelerometer data.  $Rot_{xz}$  and  $Rot_{yz}$  are obtained from the gyroscope ADC values and represent measures of the rotation of the projections of the vector of inertia respectively on the XZ and YZ planes. This defines respectively the rotation around the X and Y axis.  $V_{ref}$  is the reference voltage of the converter. As well as the accelerometer  $V_{ref}$  it is usually the power supply voltage of the module.  $V_{zeroRate}$  is the voltage to speed angular zero, i.e. the voltage when the gyro is subject to no rotation. The values of voltage at angular speed zero ( $V_{zeroRate}$ ) are provided by the manufacturer technical specifications. However, most of gyroscopes have a slight shift after welding. If we want to measure exactly  $V_{zeroRate}$  for each axis, it is necessary to implement a calibration procedure to determine this value before commissioning. The gyroscope is kept still during this calibration. The "sensitivity" of the gyroscope is expressed in  $mV/(deg/s)$ . Values of references used for the calculations are available in the sensor specification document (Datasheet).

Adding a magnetometer will allow to represent directions detected by the IMU in a geographic coordinate system based on the magnetic north. A magnetic field MEMS sensor, or magnetometer, is a device on a small scale to detect and measure magnetic fields. Many of these sensors operate by detecting the effects of the Lorentz force: a variation of voltage or a variation of resonance frequency can be measured electronically; a mechanical displacement can be measured optically. The effects of temperature must be compensated. A MEMS magnetometer is small, thus easy to integrate. It has a good spatial resolution. Its cost is low and its integration allows to reduce the size of the entire system of detection of the magnetic field.

If we use a magnetometer aligned to a single axis, we can only measure amplitude according to this axis. If the axis is located in the axis of the magnetic field, we can measure maximum amplitude on this axis. But if there is an angle between the axis of the sensor and the axis of the magnetic field, the measured amplitude will decrease. If this sensor axis is perpendicular to the direction of the magnetic field, the measurement will be equal to zero. If the direction of the magnetic North is lost, we can only estimate that it is located at  $90^\circ$ , but we do not know which side or its intensity. By adding a second axis, we can measure the direction of the magnetic field in a plane. By adding a third and last axis, it is possible to determine the direction of the magnetic field in space, regardless of the orientation of the sensor.

The problem of the magnetometer is its sensitivity to ferro-magnetic metals and to local EM fields. This can bias the

measures of the sensor. Therefore it must be taken into account including when it operates.

### 2.3. Need for a hybridisation

Using data produced by the two types of sensors (accelerometer and gyroscope) produces a better estimate of orientation and movement of a moving object. The data from these two sensors can be merged (data fusion) together to increase precision in high and low frequency movements. The gyroscope is more accurate during low frequency movements while the accelerometer is more accurate during high frequency movements (see fig. 10). Therefore, the merger of the two sensors is a way to compensate for their respective derivatives and to obtain a better estimate on a wider range of frequencies [37].

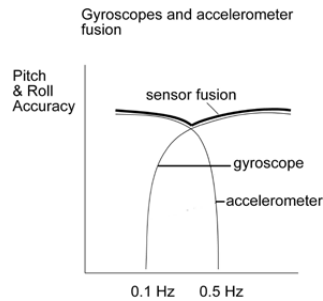

Fig. 10: Gyroscope and accelerometer fusion (from [38])

The magnetometer is used to measure the orientation of the external magnetic field (Earth's magnetic field) compared with the autonomous system. The coupling of a magnetometer with an accelerometer and gyroscope allows to build a high-performance inertial system (see fig. 11). This device is called an IMU 9 - DoF.

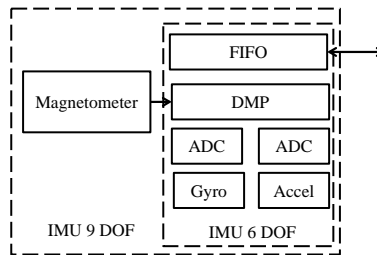

Fig. 11: IMU 9 DoF (schematic diagram)

This composition (9 DoF) determines the attitude and orientation of the autonomous system: i) during stoppings, the 3D accelerometer provides the inclination of the system based on the direction of the gravitational acceleration; (ii) knowing the tilt direction with respect to the magnetic North is determined by projecting the vector of the magnetic field on the horizontal plane; (iii) during motion, the integration of the angular speed provided by the gyroscope updates estimate of orientation.

The first difficulty is that the data is obtained by integration, i.e. by successive sums. However the measurement process cannot be truly continuous, so the successive sums will necessarily introduce small errors. Thus, even with a perfectly accurate measure of acceleration, the estimate of the speed deviates gradually, resulting from accumulated errors. The position is obtained by integrating speed with its integration error. So the position error will be quadratic compared to the initial approximations. It is therefore necessary to implement a method to reduce errors due to the integration process. The integration errors of the gyroscope can be reduced by combining it with the orientation measures produced by the magnetometer and the accelerometer. The magnetometer is less reactive but has the advantage of no drift. It is a slow correction that cancels the error of gyroscope integration gradually and continuously.

The IMU are not affected by the environment in which they operate, and they are completely autonomous. They

require no external signal in order to calculate a solution. However, given the inherent errors in inertial sensor measures (gyroscopes and accelerometers), the estimated position calculated by the IMU is not exact and tends to drift over time. According to [39, 40] this drift can reach up to 500 meter/hour even for high accuracy stand-alone IMU systems. Therefore, it is necessary to periodically correct this error using external measures to keep it below a tolerable threshold.

### 3. Attitude determination

A ball-joint connection binds completely two-piece in translation but leave them free to rotate. It has therefore 3 degrees of connections: 3 translations and 3 degrees of freedom (DoF): 3 rotations. Figure 12 shows the problematic of our Rover equipped with distributed network antennas located on different modules. To illustrate, we focus on the acoustic antenna (sonar) dedicated to anti-collision and obstacle avoidance. It is necessary to reconstruct the geometry of the sonar antenna which is composed of eight separate acoustic sensors. In addition, each extremity module (2) of the Rover is equipped with such an antenna. Modules are connected to the others by a ball-joint with 3 DoF, each one being able to take a different attitude. It is necessary to define the two sonar antenna location, one relatively to the other. To reach this objective, it is necessary to take into account in the beam forming the pitch angle ( $\rho$ ), roll angle ( $\varphi$ ) and yaw angle ( $\theta$ ) defining the attitude of each antenna from the beam.

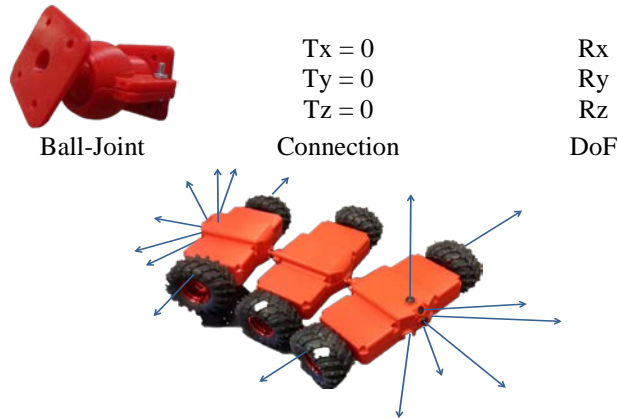

Fig. 12 : Importance of attitude for electronic beam forming

Sonar antennas are located on just 2 module extremities. But, the Ground Penetration Radar (GPR) antennas are located on each module (3). GPR antenna is composed of several elements located under each module. The beam forming and the reconstitution of the antennas geometry require these accurate data describing the attitude of each module.

The accelerometer readings provide precise orientation angles as long as gravity is the only force acting on the sensor. The forces due to the displacement and rotation of the autonomous system cause a fluctuation of these measures. The data produced by the accelerometer are corrupted by noise and brief disturbances. If we average the data on time scales longer than the duration of the disturbances, the accelerometer provides more accurate results. Figure 13 illustrates the calculation of the roll ( $\rho$ ), pitch ( $\varphi$ ) and yaw ( $\theta$ ) endured by the autonomous system (Rover) based on the acceleration values measured on each of the axes ( $x, y, z$ ).

$$\rho = \tan^{-1} \left( \frac{A_x}{\sqrt{A_y^2 + A_z^2}} \right) \quad \varphi = \tan^{-1} \left( \frac{A_y}{\sqrt{A_x^2 + A_z^2}} \right) \quad \theta = \tan^{-1} \left( \frac{\sqrt{A_x^2 + A_y^2}}{A_z} \right)$$

Fig. 13 : Calculation of pitch angles ( $\rho$ ), roll ( $\varphi$ ) and yaw ( $\theta$ )

Gyroscope measures the angular velocity (rate of change of angle) and not the orientation angle itself. To calculate the orientation, we first initialise the sensor position with a known value (accelerometer), then measure the angular speed ( $\omega$ ) around the axes  $X$ ,  $Y$  and  $Z$  at short intervals ( $\Delta_t$ ). Then it is possible to use the product ( $\omega \times \Delta_t$ ) to estimate the change of angle. The new orientation angle at  $\Delta_t + 1$  is the angle value at  $\Delta_t$  plus the value of the angle variation. Repeated integration of ( $\omega \times \Delta_t$ ) will result in small systematic errors increasing with time. It is the cause of gyroscopic drift which makes the data more and more imprecise over time.

In conclusion, the accelerometer and gyroscope data are subject to systematic errors. The accelerometer provides accurate data on the long term, but its data are corrupted by noise in the short term. The gyroscope provides accurate data on changing the orientation in the short term, but integration causes a drift of the results on longer time scales. The solution to these problems is to merge data (data fusion) from the accelerometer and gyroscope to reduce and cancel these errors. A usual method is to combine these two data sources with a Kalman filter to estimate parameters of a system evolving in time using measurements. This approach produces better results but requires to implement quite complex calculations. This may require using more powerful computing processors and therefore will have a higher power consumption. The power consumption of the autonomous system has an immediate effect mainly on weight of battery and autonomy (mission duration).

### 3.1. Coupling IMU and Odometer

The knowledge of the precise and continuous location is essential to navigation, as well as the knowledge of the precise location of the identified targets: objects or buried victims. This type of autonomous equipment, intended to better approach earthquake victims, cannot be based on GNSS techniques that require wireless radio communications. Inside of a building, in a basement, under the debris of a destroyed building, etc., radio signals have difficulties to penetrate. Therefore, it is required to implement techniques able to operate in this particular, heterogeneous and dangerous environment.

An usual and simple method is odometry which provides a relative location. By measuring its moves from its point of origin, it is possible to calculate the position and orientation of an object at every moment. To do this, for example, you can implement a system of numerical thumbwheels on the axes of each engine or of each wheel. At each time interval, the system acquires the number of pulses generated by the coders. The pulse number is proportional to the distance covered. The speed measurement is done simply by counting the number of pulses for a fixed time. In our autonomous system (Rover) the coders are fixed on each engine axes.

The hypotheses of the problem are the following: i) the encoders are fixed to the motor axis and not to the gearbox axis. the reduction ratio (*Ratio*) is 75:1, the motor axis makes 75 laps when the main axis makes only one lap; ii) the encoder generates 48 pulses (*CPR*) for each lap; iii) the sampling value used for feedback servo is 0.01 s.

Therefore, for each lap of the main axis, the coder generates: ( $75 * 48$ ) = 3600 impulses. If  $N$  is the number of pulses counted in 0.01 s ( $T_s$ ), the speed will be obtained by (in rad/s):

$$V = \frac{2 * \pi * N}{T_s * CPR * Ratio} \quad \text{rad/Sec}$$

A very important point concerns the resolution of the measure, that is, the smallest value that it is possible to calculate. The lowest possible resolution will be sought in order to obtain a good measurement accuracy.  $T_s$  and/or *CPR* and/or *Ratio* must be chosen as large as possible. However, *Ratio* is fixed by the engine torque or the maximum speed desired whereas  $T_s$  must be smaller than the response time expected for the servo loop of the engine. Therefore, the only real possibility is to adjust the *CPR*. When choosing an incremental encoder, it is preferable to choose one that allows to get the most impulses by turn.

In our architecture the resolution is:

$$resolution = \left( \frac{2 * \pi}{T_s * CPR * Ratio} \right) = \left( \frac{2 * \pi}{0.01 * 48 * 75} \right) = 0.1745 \quad \text{Rad/sec}$$

With  $T_s$ : sampling rate; *CP*: encoder number of pulses by turn and *Ratio*: engine reduction rate. The calculation of the covered distance  $d$  is obtained by the simple formula:

$$d = \left( \frac{\pi * D}{360} \right) * nbTicks$$

With  $d$ : covered distance,  $D$ : diameter of the wheel,  $nbTicks$ : number of pulses generated by the encoder.

In order to estimate the speed and rotation values, it is necessary to implement a simple type regulator PID (proportionate Integral derivative). This PID controller continuously calculates an error value  $e(t)$  i.e. the difference between a desired setpoint  $r(t)$  and a measured process variable  $y(t)$ ; it applies a correction based on proportional, integral, and derivative terms. The controller attempts to minimize the error (see fig. 14) over time by adjustment of a control variable  $u(t)$ . Figure 14 describes the principle of the PID regulation.

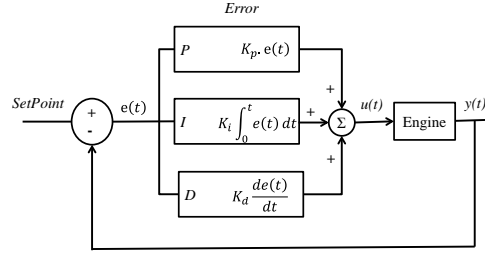
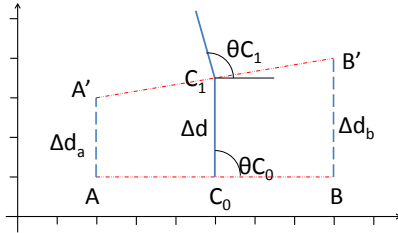

Fig. 14: PID control principle

To reconstruct the trajectory, a simple method is the approximation by line segment. This method assumes that the trajectory is sliced into a series of segments. At each time interval, the autonomous system performs a rectilinear movement following its previous orientation. However, this single information is not sufficient for self-location of the engine in a coordinate system.

Naming  $d$ : covered distance,  $\theta$ : orientation of the autonomous system and  $E$ : distance between the wheels, it is possible to calculate the new device coordinates as well as its orientation.



$$\Delta d = (\Delta d_a + \Delta d_b)$$

$$\Delta \theta = \tan^{-1} \left[ \frac{(\Delta d_a + \Delta d_b)}{E} \right],$$

considering that  $\Delta \theta$  is low, it is possible to simplify using the Gauss approximation:  $\Delta \theta = (\Delta d_a + \Delta d_b) / E$

$$\Delta x = \Delta d \cos \theta C_0 ; \quad \Delta y = \Delta d \sin \theta C_0$$

$$x C_1 = x C_0 + \Delta x = x C_0 + (\Delta d \cos \theta A) \quad \text{et} \quad y C_1 = y C_0 + \Delta y = y C_0 + (\Delta d \sin \theta A)$$

$$\theta C_1 = \theta C_0 + \Delta \theta = \theta C_0 + \left[ \frac{(\Delta d_a - \Delta d_b)}{E} \right]$$

Fig. 15: Approximation by line segment Method

The above approximation is easy to implement on a small microcontroller. It produces however a fairly rough approximation and can cause a significant drift over a long run.

The approximation by arc of a circle remains a simple method to improve a reconstruction of trajectory. .At each interval of time, we consider that the device performs a circular arc with a radius  $R$  and angle  $\alpha$  (see below).

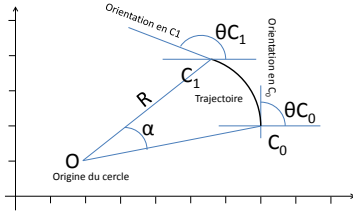

We assume:  $\Delta d = \overline{(\Delta d_a + \Delta d_b)}$  et :  $\Delta \theta = (\Delta d_a + \Delta d_b) / E$

We can calculate the radius R (considered at E/2) and the coordinates of the centre of the circular arc:

$$R = \frac{\Delta d}{\Delta \theta} ; \quad xO = xC_0 - R \sin \theta C_0 ; \quad yO = yC_0 + R \cos \theta C_0$$

Fig. 16: Approximation by circle Method

The coordinates of the centre of the mobile (E/2) and its orientation is obtained by:

$$\theta C_1 = \theta C_0 + \Delta \theta = \theta C_0 + \left[ \frac{(\Delta d_a - \Delta d_b)}{E} \right]$$

$$xC_1 = xC_0 + R \sin \theta C_1 \quad \text{et} \quad yC_1 = yC_0 + R \cos \theta C_1$$

In case  $\Delta \theta = 0$ , the Rover goes straight, we can use:

$$xC_1 = xC_0 + \Delta d \cos \theta C_1 \quad \text{et} \quad yC_1 = yC_0 + \Delta d \sin \theta C_1$$

This approximation is more accurate than the approximation by segment but will require more calculations, which can induce more powerful microprocessors that will consume more energy. But it suffers the same limitations as the previous method. It is mainly the drift that will grow with the length of the run. As we have seen above we cannot found the localization process on radio navigation-satellite service (RNSS). The odometry technique is applicable on short run, but it does not solve the problem of drift. This drift based on elapsed time in inertial techniques was already mentioned above. Thus the solution seems to use the most appropriate technique depending on the environment and regular updating mechanisms based on information produced by the various on-board sensors.

### 3.2. Updating mechanisms and Retiming

The first proposed mechanism is to use the stoppings of the autonomous system, natural or provoked, to carry out control and recalibration of the sensors. The principle remains simple. Periodic stoppings are required. This allows to check the potential drift of sensors by verifying if the  $V_{zeroG}$  and  $V_{zeroRate}$  values are compatible with the specification values (see sensor Datasheet). In case these values differ they have to be corrected by a retiming process. The "stoppings" have also another advantage. All power consuming parts including the motors are turned off. As a result the EM disturbances are significantly reduced, a configuration which presents a great interest for the magnetometer verification. This sensor is indeed sensitive to EM perturbations..

The operational movement of the Rover is reduced, about two kilometres per hour, but has no significant impact on its operational capacity.

The sensors embarked on the engine as payload can also participate in the navigation, for example in integrating the variation of distances to an obstacle obtained by an acoustic sensor.

## 4. External hybridization

The desired objective to correct the IMU functioning by the readjustments based on GNSS signals whenever possible consists in using the measures from the two different devices described above in order to readjust the position obtained with the IMU. Reception difficulties of GNSS signals will arise in such an environment where the autonomous system evolves. During the large part of its mission, the engine is supposed to navigate underground (under the debris, inside the buildings, and so on). The system evolves in such a way that the reception of electromagnetic waves is questionable. Many studies have been made on this subject. As a first step, we will apply a classical approach based on existing results : i) detection of the GNSS signal based mainly on the strength of the signal and on the number of visible satellites ; ii) stoppings and estimation of a GNSS (GNSS-fix) position; iii) correction of drift based on obtained GNSS positions.

It is also possible to use a localisation beacon system. The complexity of the propagation phenomena in a building [41, 42] makes the application of acoustic methods ineffective, therefore we suggest a radio-wave approach. Navigation in a heterogeneous environment requires special attention.

The volume to explore is small, in a range of a building or a building block, approximately 50 metres by 50 meters on 15 to 30 meters high. This configuration is favourable to the implementation of a technique of local geo-location based on radio-wave antennae positioned around the investigation area. The autonomous system is carrying a radio beacon. The estimation of the position engine is obtained by geolocation based on antenna processing with synchronized receivers.

The choice of this configuration has been encouraged by the results described in [43, 44] see figure 17. These results drove us to install radio stations outside the exploration main volume, and to process the received signals in one-step. The characteristics of ground signal propagation drove us to select a low frequency band, e.g. 6 765-6 795 kHz with 6 780 kHz as central frequency. This band is an ISM band thus offering some freedom for development and experimentation. Yet, the multi-path issue is still to be explored, both from the propagation itself and from the signal processing to be performed.

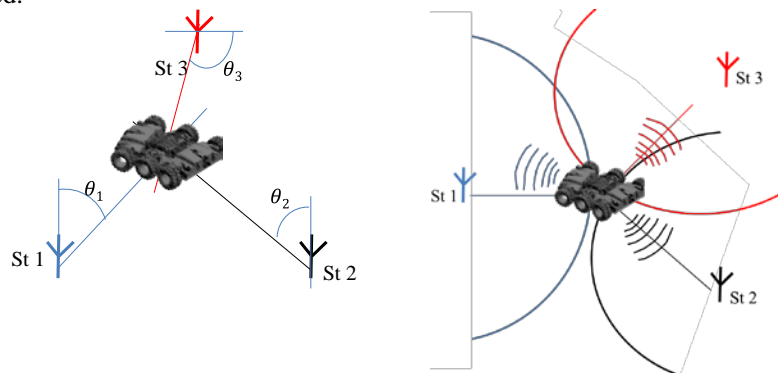

*Triangulation: the position  $p$  of the transmitter is estimated through the various directions of arrival ( $\theta_1$ ,  $\theta_2$  et  $\theta_3$ )*

*TOA-based location: the transmitter is located through the various Time Of Arrival ( $\tau_1$ ,  $\tau_2$  and  $\tau_3$ )*

Fig. 17 : Some positioning system (from [44])

There are few means to safely communicate with the rover; fortunately the amount of information to be transmitted is relatively small. The bandwidth resulting from the modulation of the central frequency used for both communication and location will therefore be small. The proposed frequency band (ISM: Industrial, Scientific and Medical radio bands) is experimental. Later, if necessary, discussions could be envisaged on the opportunity of the band in accordance with frequency bands used/identified for PPDR.

## 5. Outlook and conclusions

The use of autonomous engines either on the ground (Rover) or flying (Drone) is without any doubt an improvement. They are able to attain unattainable and dangerous locations. Moreover they are less sensitive to both environmental conditions such as meteorology and stressful situations for human beings. However, in order to achieve this autonomy several difficulties have to be resolved.

With respect to the energy, even if it is not the subject of this paper, it constitutes a major difficulty because of the actual energetic density presently attainable (about 350 Wh/kg). In the case of a flying engine, as for example a drone, the difficulty is even greater. In addition to the energy needed to move the engine, more energy is necessary for the sensors on board the engine.

Moreover the autonomous navigation implies a constant positioning of the engine, without the help of radio-navigation systems. Indeed, the environment is generally not favourable for the propagation of EM waves. Therefore it is not possible to count on a systematic re-setting of the estimated position by GNSS.

From the navigation point of view numerous researches are under way, particularly in the field of robotics, the main difficulty to be solved being the application of the researches under the conditions described above. Several types of sensors exist but the conditions of their use are unusual requiring to determine the effects on their performances. This aspect is beyond the scope of the paper, nevertheless the type of sensors selected will contribute to the navigation of the rover at short range. Generally speaking to the extent that the conditions of navigation/location are better known and modelled expectations are high concerning application of results from robotics and AI.

Figure 18 shows the architecture of the circuits dedicated to the location function embarked on the Rover.

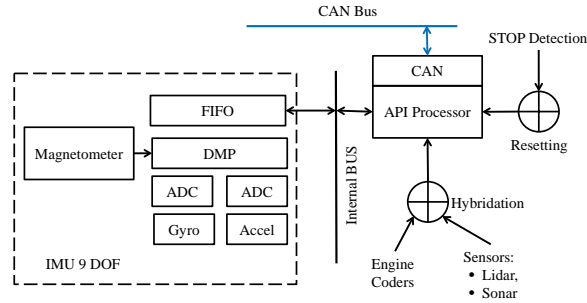

Fig. 18: Determination of position and movements

The sensors presently available are paradoxically more efficient and easily adaptable than the means for navigation and location. This is because the former benefit of many researches currently underway, mainly by petrol and gaz industries. It has to be recognised that the knowledge of propagation of EM waves in a heterogeneous environment is lacking. In particular it would be interesting to know if there is a parameter which can be detected by external stations. This parameter could be the average duration of propagation of the waves in the medium.

The elaboration of propagation models at meso-scales is becoming essential for both navigation and communication. Moreover compatibility studies will have to be made for both the engine as such and surrounding appliances.

Various types of miniature sensors can be used although under special conditions and at short range, eventually with a very short *punctum proximum*. The observation results are processed on board the engine and transmitted to an outside station by a beacon placed on board the engine. The necessary bandwidth is limited; nevertheless methods exist to take into account the case of signals which have a product duration x bandwidth lower than one. In addition to location the same difficulty exists for the communication towards the outside. As soon as a victim is detected the position has to be transmitted.

### 5.1 Perspectives and future research

There are three major areas for research: i) the energetic aspect which is not discussed in the present paper, ii) the optimisation of the avionics and iii) communications which remain an area where relevant data are lacking for such a complex environment. As far as EM waves are concerned two subjects need further investigations. First propagation under the Earth surface and at short distance of decametric waves (HF). Second, only few experimental results are available in this band on the efficiency of small antennas in systems which usually use a ground system as a factor in antenna efficiency to act as a low «spreader» of current along the surface of the Earth. Extensive calculation has been made some time ago by Maley and King [46] on antenna efficiency, although their aim was different. In the present case measurements have to be made.

At present we are prepared to undertake a series of tests to validate the above approach. At first our validation tests will be made in an indoor environment; this will allow to test if the engine (Rover) works properly. Secondly we will test the engine on an outside ground and without the help of GNSS. Finally tests will be carried out in an environment similar to a collapsed construction.



## References

- [1] D. Guha-Sapir D, Ph. Hoyois, R. Below, "Annual Disaster Statistical Review 2012: The number and trends", Brussels: CRED, 2013.
- [2] T. Tanzi and P. Perrot, *Télécoms pour l'ingénierie du risque* (in French), éditions hermès ed. Collection Technique et Scientifique des Télécoms, Paris, France. 2009.
- [3] T.J. Tanzi and F. Lefeuvre, "Radio sciences and disaster management", *C.R. Physique* 11, 114-224, 2010.
- [4] Tanzi, Tullio Joseph; Isnard, Jean. (2015). "Introduction to Public safety networks" Chapter of book, In *Public safety Book volume 1: Overview and Challenges*. Published by Wiley-ISTE. 2015.
- [5] F. Lefeuvre and T. Tanzi, "International Union of Radio Science, International Council for Science (ICSU), Joint Board of Geospatial Information Societies (jGBIS)," in *United Nations office for outer Space Affairs (OOSA)*, 2013.
- [6] Gadamer, A.; Petitpas, B.; Beaudoin, L.; Tanzi, T.J.; Riera, B.; Rudant, JP.; "Using centimetric visible imagery obtained from an UAV quadrotor for classification of ERS images". *European Space Agency ESA Living Planet Symposium*, Bergen, 2010.
- [7] D. Camara. *Cavalry to the Rescue: Drones Fleet to Help Rescuers Operations over Disasters Scenarios*. In *IEEE Conference on Antenna Measurements & Applications (CAMA)*.Antibes, France, 2014
- [8] P. Wilkinson and D. Cole, "The Role of the Radio Sciences in the Disaster Management," *Radio Science Bulletin*, vol. 3358, pp. 45-51, 2010.
- [9] T. Tanzi and F. Lefeuvre, "The Contribution of Radio Sciences to Disaster Management," in *International Symposium on Geo-information for disaster management (Gi4DM 2011)*, Antalya, Turkey, 2011.
- [10] Madhu Chandra and Tullio Joseph Tanzi, (2017). "Drone-Borne GPR Design: Propagation Issues," in *Journées scientifiques de l'URSI-France (JS'17)*
- [11] Sylvie Servigne, Yann Gripay, Ozgun Pinarer, John Samuel, Atay Ozgovde & Jacques Jay, (2016). "Heterogeneous Sensor Data Exploration and Sustainable Declarative Monitoring Architecture: Application to Smart Building". *First International Conference on Smart Data and Smart Cities*, 30th UDMS, 9 septembre 2016, Split (Croatie), pp. 97-104, doi : 10.5194/isprs-annals-IV-4-W1-97-2016.
- [12] Tanzi, Tullio Joseph; Roudier, Yves; Apvrille, Ludovic. (2015). "Towards a new architecture for autonomous data collection". *ISPRS Geospatial Week 2015: Workshop on civil Unmanned Aerial Vehicles for geospatial data acquisition*. 1-2 October, 2015. La Grande Motte (Montpellier), France.
- [13] Ludovic Apvrille, Tullio Joseph Tanzi, Yves Roudier, and Jean-Luc Dugelay. (2017) "Drone "humanitaire : état de l'art et réflexions," *Revue Française de Photogrammétrie et de Télédétection*, pp. 63-71, N 213-04-26. 2017. ISSN 1768-9791
- [14] Tullio Joseph Tanzi, Madhu Chandra, Jean Isnard, Daniel Camara, Olivier Sebastien, Fanilo Harivelo. (2016) "Towards rone-Borne Disaster Management: Future Application Scenarios ". 06/2016; III-8:181-189. DOI:10.5194/isprs-annals-III-8-181-2016
- [15] E. Ackerman, "Drone Adventures Uses UAVs to Help Make the World a Better Place," *IEEE Spectrum*, May 2013.
- [16] Tanzi T. J., Roudier Y. and Apvrille L., (2015), "Towards a new architecture for autonomous data collection", *Int. Arch. Photogramm. Remote Sens. Spatial Inf. Sci.*, vol. XL-3/W3, pp. 363-369.
- [17] O. Sebastien, F. Harivelo, D. Sebastien, "Using general public connected devices for disasters victims location", *31th URSI GASS*, Beijing, China, August 2014.
- [18] *Introduction to Ground Penetrating Radar: Inverse Scattering and Data Processing*, Raffaele Persico, John Wiley, 2014, ISBN: 9781118305003
- [19] - Rec. ITU-R SM.1754 Measurement techniques of ultra-wideband transmissions, Rec. ITU-R SM.1755 Characteristics, Rec. ITU-R SM.1756 Framework & Rec. ITU-R SM.1757 Impact of ultra-wideband technology
- [20] Ozgun Pinarer, Yann Gripay, Sylvie Servigne, Ozgovde Atay & Atilla Baskurt (2017). "Dynamic energy-aware sensor configuration in multi-application monitoring systems". *Pervasive and Mobile Computing*, vol. 41, pp. 192-204
- [21] Ozgun Pinarer, Yann Gripay, Sylvie Servigne & Atay Ozgovde. (2016). "Energy Enhancement of Multi-application Monitoring Systems for Smart Buildings". *CAiSE'16: Conference on Advanced Information Systems Engineering - EnBIS: Energy-awareness and Big Data Management in Information Systems*, 17 juin 2016, Ljubljana (Slovénie), pp 131-142. doi : 10.1007/978-3-319-39564-7\_14
- [22] Claudia Gutierrez Rodriguez & Sylvie Servigne (2013). "Managing Sensor Data Uncertainty: a data quality approach". *International Journal of Agricultural and Environmental Information Systems (IAEIS)*, vol. 4, pp. 35-54.
- [23] Yves Roudier and Tullio Joseph Tanzi, (2017). "A State of the Art of Drone (In)Security," in *Journées scientifiques de l'URSI-France (JS'17)*.
- [24] Hendrik Schwappe, Yves Roudier. *Security and Privacy for In-Vehicle Networks*, in *Proceedings of VCSC 2012, 1st IEEE SECON International Workshop on Vehicular Communications, Sensing*.
- [25] H. Schwappe, Y. Roudier, B. Weyl, L. Apvrille, and D. Scheuer-mann, "C2X Communication: Securing the Last Meter," in *The 4th IEEE International Symposium on Wireless Vehicular Communications: WIVEX2011*, San Francisco, USA, Sep. 2011.
- [26] - *IEEE A&E Systems magazine*, Volume 33 Number 5-6 May-Juin 2018,
- [27] M. Chandra, "Overview of Modern Multi-parameter Methods of Radar Remote Sensing in Context of Disaster Management" in *XXXI General Assembly and Scientific Symposium of the International Union of Radio Science (URSI GASS 2014)*. *ISPRS-URSI Disaster management special session*. August 17-23, Beijing, China (CIE), 2014.
- [28] Rec. ITU-R P. 527-4 *Electrical characteristics of the surface of the Earth*;
- [29] B. Ranft, J.-L. Dugelay, and L. Apvrille, "3D Perception for Autonomous Navigation of a Low-Cost MAV using Minimal Landmarks," in *International Micro Air Vehicle Conference and Flight Competition (IMAV'2013)*, Toulouse, France, Sept 2013.
- [30] L. Apvrille, J.-L. Dugelay, and B. Ranft, "Indoor Autonomous Navigation of Low-Cost MAVs Using Landmarks and 3D Perception," in *OCOSS 2013*, Nice, France, Oct. 2013.
- [31] Najib Kacem, Sebastien Hentz, Sébastien Baguet, Régis Dufour. *Capteurs résonants M/NEMS et phénomènes non linéaires*. *Acoustique et Techniques*, 2009, pp.10-14.
- [32] Alexandre Bongrain. *Nouvelles technologies de capteurs MEMS en diamant pour des applications de transduction*. Autre. Université Paris-Est, 2011. Français
- [33] Alexis Brenes. *Modélisation des phénomènes non-linéaires dans un capteur MEMS résonant pour l'optimisation de ses performances et de sa fiabilité*. Autre. Université Paris-Saclay, 2016.
- [34] PCB Piezotronics. [Online]. [http://www.pcb.com/TechSupport/Tech\\_Accel.aspx](http://www.pcb.com/TechSupport/Tech_Accel.aspx)
- [35] Dimension Engineering. [Online]. <http://www.dimensionengineering.com/info/accelerometers>

- [36] Arvind Sanjeev. (2014, October) Arduino MPU6050 - Best IMU Sensor tutorial. <http://diyhacking.com/arduino-mpu-6050-imu-sensor-tutorial/>
- [37] MEMS Central. [http://memscentral.com/Secondlayer/mems\\_motion\\_sensor\\_perspectives-5.htm](http://memscentral.com/Secondlayer/mems_motion_sensor_perspectives-5.htm)
- [38] Peach Innovations - Rowing Telemetry and Instrumentation. <http://www.peachinnovations.com/>
- [39] Schmidt, George T. 2004. INS/GPS Technology Trends. RTO-EN-SET-064: RTO NATO.
- [40] Schmidt, George T., et Richard E. Phillips. 2004. INS/GPS Integration Architectures. RTOEN-SET-064: RTO NATO.
- [41] Rec. ITU-R P. 2040-1 Effects of building materials and structures on radiowave propagation above about 100 MHz;
- [42] Report ITU-R P. 2346-0 Compilation of measurement data relating to building entry loss (In support of the material in Rec. ITU-R P.2040).
- [43] Weiss A.J. Direct position determination of narrowband radiofrequency transmitters in IEEE Signal processing letters 11(5) pp. 513-516, 2004,
- [44] Bosse J. Géolocalisation de sources radio-électriques : stratégies, algorithmes et performances. Thèse. ENS Cachan, May 2012,
- [45] RR 5 Table of frequency allocations , UIT-R édition 2018
- [46] Maley S.W. and King R.J. « Impedance of a monopole antenna with a radial-wire ground system in a imperfectly conducting half plane» quoted in Reference data for engineers, seventh edition, Edward C. Jordan editor in chief, 1988 pp. 32-14 and following.