



HAL
open science

A Model Compilation Approach for Optimized Implementations of Signal-Processing Systems

Andrea Enrici, Julien Lallet, Imran Latif, Ludovic Apvrille, Renaud Pacalet,
Adrien Canuel

► **To cite this version:**

Andrea Enrici, Julien Lallet, Imran Latif, Ludovic Apvrille, Renaud Pacalet, et al.. A Model Compilation Approach for Optimized Implementations of Signal-Processing Systems. 6th International Conference on Model-Driven Engineering and Software Development MODELSWARD 2018, Jan 2018, Funchal Madeira, Portugal. pp.25-35, 10.5220/0006534800250035 . hal-02287718

HAL Id: hal-02287718

<https://telecom-paris.hal.science/hal-02287718>

Submitted on 14 Mar 2024

HAL is a multi-disciplinary open access archive for the deposit and dissemination of scientific research documents, whether they are published or not. The documents may come from teaching and research institutions in France or abroad, or from public or private research centers.

L'archive ouverte pluridisciplinaire **HAL**, est destinée au dépôt et à la diffusion de documents scientifiques de niveau recherche, publiés ou non, émanant des établissements d'enseignement et de recherche français ou étrangers, des laboratoires publics ou privés.

A Model Compilation Approach for Optimized Implementations of Signal-Processing Systems

Keywords: Domain-Specific Modeling, Model Transformation, Model-Driven Architecture

Abstract: To meet the computational and flexibility requirements of future 5G networks, the signal-processing functions of baseband stations and user equipments will be accelerated onto programmable, configurable and hard-wired components (e.g., CPUs, FPGAs, hardware accelerators). Such mixed architectures urge the need to automatically generate efficient implementations from high-level models. Existing model-based approaches can generate executable implementations of Systems-on-Chip (SoCs) by translating models into multiple SoC-programming languages (e.g., C/C++, OpenCL, Verilog/VHDL). However, these translations do not typically consider the optimization of non-functional properties (e.g., memory footprint, scheduling). This paper proposes a novel approach where system-level models are optimized and compiled into multiple implementations for different SoC architectures. We show the effectiveness of our approach with the compilation of UML/SysML models of a 5G decoder. Our solution generates both a software implementation for a Digital Signal Processor platform and a hardware-software implementation for a platform based on hardware Intellectual Property (IP) blocks. Overall, we achieve a memory footprint reduction of 72.7% in the first case and 88.93% in the second case.

1 INTRODUCTION

Future 5G networks are expected to provide higher data-rates (10x with respect to 4G) to support use cases such as the Internet of Things (IoT) and cloud computing (e.g., Cloud Radio Access Networks). The equipment of current baseband stations is designed with mixed architectures that contain both programmable (CPUs, Digital Signal Processors - DSPs) and configurable (Field Programmable Gate Arrays - FPGAs) components. To meet the computational requirements of the above 5G use cases, the functions (e.g., signal-processing operations) executed by both components will change over time instead of being statically allocated. This raises the need for unified solutions capable to efficiently prototype designs of 5G mixed architectures.

Model-Driven Engineering (MDE) (Schmidt, 2006) is widely accepted in the signal-processing domain as the most promising design paradigm to cope with these issues. MDE combines domain-specific modeling languages to abstract the structure, behavior and requirements of a system under design, with transformation engines and generators. The latter analyze models and produce artifacts such as source code, simulation, verification inputs or alternative model representations.

In the context of MDE for 5G Systems-on-Chip, an important research problem is the efficient translation

of system-level models – that abstract implementation details – into executable implementations. Challenges arise from the desire to generate executable code for different architectures (e.g., General-Purpose Control Processors, FPGAs), implementations (i.e., software, hardware and mixed hardware-software) and execution units (e.g., DSPs, CPUs, Hardware Accelerators). This paper proposes a compilation approach for model-based specifications of SoCs, regardless of their final realization technology (e.g., FPGA, Application Specific Integrated Circuit - ASIC). Models are given as input to a model compiler that optimizes the system's memory footprint and generates a behaviorally equivalent ANSI C program. As a practical case study we propose the model-based design of a 5G datalink-layer decoder. The program compiled from the decoder's models is transformed into executable implementations for (i) a DSP-based platform (software executable file) and (ii) a hardware IP-based platform (FPGA bitstream) by a traditional software compiler and a SoC design tool.

The rest of the paper is organized as follows. Section 2 positions our work with respect to related contributions. The structure of the compiler and its implementation are respectively described in Section 3 and Section 4. Section 5 describes the model-based design and compilation of the UML/SysML diagrams for the 5G decoder. Section 6 concludes this paper and discusses our future work.

2 RELATED WORK

In the context of UML-based MDE, code generation for SoCs is based on a direct *translation* of UML modeling assets into constructs of a target language (e.g., a UML block becomes a C function), according to precise translation rules (Vanderperren et al., 2012). Many works propose one-to-one translation rules for SoC languages such as C (Nicolas et al., 2014), C++ (Ciccozzi et al., 2012), Verilog (Bazydlo et al., 2014), VHDL (Moreira et al., 2010) and SystemC (Mischkalla et al., 2010; Xi et al., 2005; Tan et al., 2004). A representative work that uses one-to-many translation rules is Gaspard2 (Graphical Array Specification for Parallel and Distributed Computing) (Gamatie et al., 2008; DaRTteam, 2009), a MDE SoC co-design framework based on MARTE. Thanks to the notion of *Deployment*, in Gaspard2 an Elementary Component (a resource or a functionality in a MARTE model) is related to implementation code that specifies low-level behavioral or structural details in a usual programming language (e.g., C/C++) for formal verification, simulation, software execution and hardware synthesis.

Executable UML (xUML) or *executable and translatable UML* (xtUML) (Mellor and Balcer, 2003; Mellor and Balcer, 2002) defines both a software development methodology and a highly abstract software language that combines a subset of UML's graphical notation with executable semantics and timing rules. When "programming" in xUML, a system's application is captured in the metamodel. The model compiler comprises some library code and a set of rules that are interpreted against the metamodel to produce text for a target SoC (e.g., C++ classes, C structs; VHDL specifications for hardware registers). However, the overall architecture of the generated SoC is defined by the model compiler itself (i.e., its translation rules). As opposed to our approach, xUML considers a platform-*independent* model as input. To the best of our knowledge, no work exists that attempts to optimize the performance of code generated from the xUML subset.

The Foundational Subset for Executable UML Models (fUML) (fUML, 2016) and the Action Language for fUML (Alf) (Alf, 2017) standard were created to make xUML models detailed enough and well specified for detailed programming and machine execution. The goal of fUML is to go beyond xUML in specifying a reasonable subset of UML with a precise semantics, in order not to be specific to any executable modeling methodology. The syntax of Alf is borrowed from Java, C, C++ and C# to specify the behavior and computation (concurrent data-flow semantics)

of graphical fUML models. xUML, fUML and Alf are essentially focused on specifying a semantics suitable to generate executable code from UML graphical models. With respect to this, our work goes one step further. Our model compiler demonstrates that non-functional properties of a system denoted with UML/SysML diagrams can be improved before code generation, with a significant impact on the performance of the final executable (e.g., memory footprint reduction).

In the 2011 edition of MODELS, the work in (Floch et al., 2011) illustrated how MDE techniques (e.g., meta-metamodels, meta-tools, Domain Specific Languages) can be applied to help in solving or simplifying issues such as code maintainability and sustainability, interfacing with external tools, semantics preserving of the Intermediate Representation transformations and code generation. While (Floch et al., 2011) tries to bridge the gap between model-based optimizations and abstract representations of pure software systems, our work transforms system-level models that also include hardware components (e.g., on-Chip RAM memories).

The landscape of industrial tools that generate SoC implementations of signal-processing applications from models is also very rich, e.g., National Instruments LabVIEW Communications System Design (Labview, 2017), MATLAB (MAtrix LABoratory) (Mathworks, 2017), GNU Radio (GNURadio, 2017). While our compilation approach targets multi-processor architectures, these tools translate models that describe the functionality of a system to be executed onto single-processor architectures where data are processed onto a single unit.

3 THE COMPILER STRUCTURE

The model compiler that we present in Fig. 1 takes as input model-based specifications (a Platform-Specific Model - PSM - and a Platform Independent Model - PIM) from a MDE design environment and produces an optimized program (Target program in Fig. 1). Prominent examples of MDE environments used in the signal-processing domain are described in (Gerstlauer et al., 2009). In these environments, a target system is first modeled, then design alternatives (PSMs) are explored until a solution that satisfies the desired requirements (e.g., latency, throughput) is found to be realized. It is this solution that our compiler takes as input.

Our compiler in Fig. 1 is inspired by those for traditional programming languages (Torczon and Cooper, 2007). However, it differs from the latter in mainly

two aspects. First, it has two inputs: a pair PIM-PSM and a library of implementation-specific functions of the computation and communication operations that are allocated in the PSM. Second, our compiler operates at a higher abstraction level, known as *system-level* (Gerstlauer and Gajski, 2002). The scale at which the compiler performs optimizations is the one of an entire system (e.g., a Multi-Processor System-on-Chip) with multiple computation, communication and storage units that can be shared, distributed or both; rather than a single processor (e.g., CPU, DSP). In analogy with traditional compilers whose middle-end attempts to optimize the allocation of CPU registers, our system-level model compiler attempts to optimize the allocation of buffers that store arrays of data in the memories of signal-processing units. In the following, we present the main components of such a compiler.

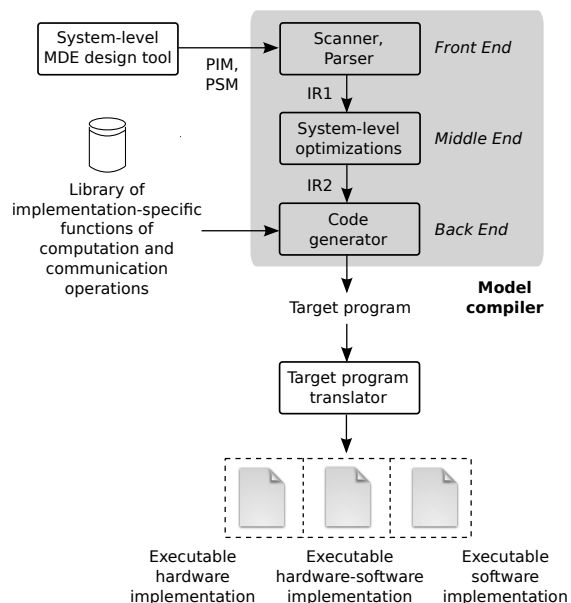

Figure 1: The model compilation approach

The **front-end** is dedicated to “understanding” – with scanning and parsing techniques – the PIM and PSM denoted in a specific modeling language (e.g., UML/SysML/MARTE, AADL) and to encode this knowledge (e.g., topology of the target platform, dependencies between functions, scheduling and memory allocation constraints imposed by hardware and software units onto the allocated functions) into an Intermediate Representation (e.g., a directed graph) IR1 in Fig. 1. IR1 must be independent of the language used to denote the models. It must also preserve their behavior.

The purpose of the **middle-end** is to attempt to rewrite IR1 in a way that is likely to optimize the performance of the final implementation in terms of memory management, power consumption, throughput, etc. Such a rewriting results in a second intermediate representation (IR2) that must respect the static allocation of functions defined in the PSM (i.e., if function A has been allocated to unit U1, it cannot migrate to another unit at run-time) and must preserve the behavior present in IR1. Examples of optimizations that can be performed at this stage are: optimizations that reduce the memory occupancy of storage units, scheduling optimizations that minimize the workload of processing and communication units.

In Fig. 1, the **back-end** is a code generator that translates IR2 into a target program written in a high-level programming language (e.g., C/C++). This program schedules the execution of computation and communication operations and also manages the allocation of the physical memory regions where data is stored to be produced and consumed. The program is generated by including a library of implementation-specific functions of computation and communication operations. The final target program must be behaviorally equivalent to IR2, IR1 and the PIM-PSM.

The **target program translator** produces an executable implementation. This can be a pure software implementation (e.g., an application that runs on top of an Operating System onto a general-purpose control processor) or a pure hardware implementation (e.g., a hardware IP-based design) or a mixed hardware-software implementation (e.g., some functionalities are executed by a general-purpose control processor and some are accelerated in hardware). In the case of implementations that require some functionality to be realized in hardware, the translator is a Computer Aided Design (CAD) toolsuite (e.g., Xilinx Vivado High Level Synthesis). In case of pure software implementations, the translator can be a traditional programming-language compiler (e.g., GNU/gcc/g++, clang, TurboC). The lower part of Fig. 1 (dotted boxes) represents all of these possible implementation types.

The compiler proposed in Fig. 1 essentially performs a series of model transformations: model-to-model in the front-end and middle-end, model-to-text in the back-end. These transformations should be formally described in order to guarantee that the output model/text of the transformation retains the semantics of the input model. However, these formal

descriptions depend not only on the formalism of the input PIM-PSM and on the language of the output target program. They also depend on the formalism of the Intermediate Representations. As stated in (Floch et al., 2011): "Since compiler IRs are abstractions used to represent programs, they are by essence models (an instance of IR is an abstraction of the given source code). In this context, the grammar of the source language, or more often the structure of IR, becomes the metamodel".

An implementation of the compiler architecture shown in Fig. 1 results in a tool that can be used to target, at the same time, different implementation types for multiple architectures. Given the pair PIM-PSM and a library of implementation-specific functions, an implementation to be executed in software (e.g., for execution on a control processor, for emulation purposes) is obtained by using a traditional compiler (e.g., GNU/gcc) for software languages. By changing the translator to a CAD tool, the same system can be realized in terms of both hardware and software components (e.g., executable file and FPGA bitstream). By changing the input models only, the same tool-chain (i.e., input MDE environment, model compiler, target program translator) and library of implementation-specific functions can target different signal-processing applications.

4 COMPILER IMPLEMENTATION

In this section, we describe an implementation of the model compilation approach in Fig. 1 that targets multi-processor Systems-on-Chip implementations for signal-processing applications.

4.1 Implementation Overview

The structure of our compiler is shown in Fig. 2. It is inspired by the code generation engine in (Enrici et al., 2017), where the middle-end is extended with memory allocation optimizations. In the following, we present the main components and data structures of this implementation.

4.2 Front-end

The front-end in Fig. 2 converts an input pair PIM-PSM model into a first intermediate representation $G = (A, E)$: a Synchronous Data Flow (SDF) graph (Lee and Parks, 1995) annotated with mapping information. The models are parsed and scanned

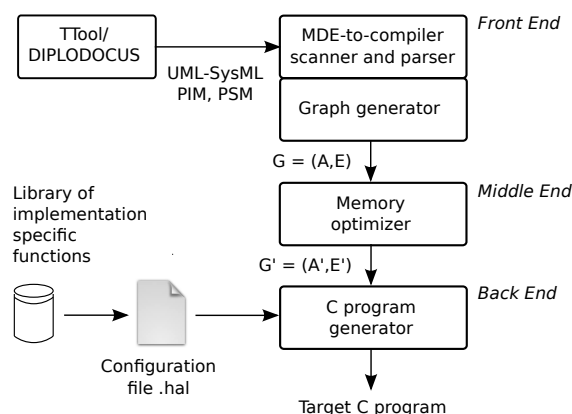

Figure 2: The implementation of the approach in Fig. 1

by a MDE-to-compiler plugin that allows the compiler to be independent of the specific modeling language used by the input MDE. In this paper, the PIM-PSM is taken from the open-source MDE framework TTool/DIPLODOCUS (Apvrille et al., 2006; Apvrille, 2008). The plugin scans and parses a PIM-PSM described in .xml format by TTool/DIPLODOCUS and passes this description to the Graph generator (Fig. 2). The latter converts a UML-SysML pair PIM-PSM (Apvrille, 2008) into a SDF graph.

In a SDF graph, nodes (actors) represent processing entities interconnected by a set of First-In First-Out (FIFO) data queues. An actor starts execution (firing) when its incoming FIFO(s) contains enough tokens, it cannot be preempted and produces tokens onto its outgoing FIFO(s). The number of tokens consumed/produced by each firing is a fixed scalar that is annotated with the graph edges. As actors have no state in the SDF Model of Computation (MoC), if enough tokens are available, an actor can start several executions in parallel. For this reason, SDF graphs naturally express the parallelism of signal-processing applications and can be statically analyzed during compilation for memory allocation optimizations.

A PIM in DIPLODOCUS is a SysML Block Definition diagram that captures the computation of a signal-processing system as well as their data and control dependencies. The internal behavior of each operation is further described with a SysML Activity diagram. As the execution of a SDF graph is not influenced by the internal variables of actors, we ignore the Activity diagrams of a DIPLODOCUS' PIM and only consider the Block Definition diagram. Moreover, as we are interested in optimizing the memory footprint of a signal-processing system, we only consider blocks in the PIM that are connected by data channels. Therefore, we produce for each block and

data channel in the PIM a SDF actor and an edge, respectively. Each actor in the resulting SDF graph G is annotated with the execution unit where it has been mapped in the PSM. A PSM in TTool/DIPLODOCUS is a UML Deployment diagram that specifies a platform's topology, its units (e.g., CPU, Direct Memory Access - DMA, memory) and each unit's performance characteristics (e.g., number of cores for a CPU, number of channels for a DMA). UML artifacts are used to map operations onto the platform's units.

4.3 Middle-end

In this version of the compiler's middle-end, we propose a system-level memory optimizer that minimizes the footprint of the *logical* buffers associated with the data channels among computations in a SysML PIM from DIPLODOCUS. In this work, we differentiate between *logical* and *physical* buffers. A physical buffer defines a range of memory addresses of a physical memory device (e.g., a Random Access Memory - RAM). A logical buffer, instead, is a virtual address space that can be mapped onto one or multiple physical buffers.

Our optimizer implements a variant of the allocation techniques presented in (Desnos et al., 2014) that we adapted to allow the sharing of input and output buffers of actors, similar to one of the memory reuse techniques presented in (Desnos et al., 2016). Essentially, the optimizer performs a series of graph transformations to deduce a lower bound for the physical buffers that must be allocated for the PIM's logical buffers.

The SDF graph G in Fig. 2 is transformed first into a single-rate SDF, where the production and consumption rates on each FIFO are made equal. The single-rate SDF is transformed into a Direct Acyclic Graph (DAG) by isolating one iteration of the single-rate SDF and by ignoring FIFOs with initial tokens. The DAG graph contains two types of memory objects:

- Communication buffers that are used to transfer tokens between consecutive actors.
- Feedback/pipeline buffers that store feedback FIFOs, i.e., buffers corresponding to (feedback) edges whose input and output port are associated with the same actor.

Our work differs from (Desnos et al., 2014) as, in the latter, a DAG also expresses an estimation of an actor's internal memory (e.g., the stack space of a task allocated by an Operating System). In the context of our research, as 5G applications are accelerated by hardware IP blocks, there is no need to

express the internal working memory of DAG actors. From the DAG, a Memory Exclusion Graph (MEG) is derived. Nodes in the MEG represent logical memory objects: FIFO buffers whose size is equal to the number of tokens in the single-rate SDF. Edges in the MEG link logical FIFO buffers that cannot be allocated to overlapping physical buffers. The MEG is then updated with mapping information from the PSM that specifies the execution constraints (scheduling) for each signal-processing operation. This allows to remove edges (exclusion relations) between nodes in the MEG. The purpose of this operation is to merge logical buffers so that physical buffers in the executable code can share common memory regions, thus reducing the total footprint of an application.

At this point, the heuristics proposed in (Desnos et al., 2014) is applied to compute a lower bound for the memory of the physical buffers. This bound is defined in (Fabri, 1979) as the weight of a Maximum Weight Clique (MWC). A *clique* is a subgraph of MEG vertices within which each pair of vertices is linked with an edge. As the memory objects of a clique cannot share memory space because they mutually exclude each other, the weight of a clique gives a lower bound to the amount of memory that must be allocated for all of the clique's buffers. This amount is equal to the sum of the sizes of all clique's buffers. The pseudo-code of the heuristics proposed in (Desnos et al., 2014) is shown in Algorithm 1.

In each iteration of the main loop (lines 6-13) in Algorithm 1, minimum cost vertices v^* are removed from C (line 8). If multiple vertices have the same cost, the vertex v with the lowest number of neighbors $|\mathcal{N}(v)|$ is removed. If the number of neighbors is equal, then the vertex v with the smallest weight $w(v)$ is removed. If there are still multiple vertices with equal properties, a random vertex v_{random} is selected. The loop iterates until the vertices in C form a clique. This condition is verified, line 6, by comparing the edge density of a clique with the edge density of the MEG subgraph formed by the remaining vertices in C . The edge density of a cliqued is defined as the ratio between existing exclusions and all possible exclusions. Such density is equal to 1.0 in the case of the complete MEG. The number of edges, nb_{edges} , is decremented at line 9 by the number of edges in L that link the removed vertex v^* to vertices in C . Lines 10-12 update the costs of the remaining vertices for the next iteration. The complexity of the heuristic algorithm is of the order of magnitude of $O(|V|^2)$, where $|V|$ is the number of vertices of the MEG subgraph.

The lower bound computed with Algorithm 1 is anno-

Algorithm 1: The MWC heuristics

```
/* C = the clique */
/* nb_edges = number of edges in C */
/* cost(.) = cost function of C */
/* v = generic vertex in C */
/* w(v) = weight of vertex v */
/* N(v) = neighbor vertices of v */
/* |N(v)| = lowest number of v's
   neighbors */
1 C ← V
2 nb_edges ← |E|
3 foreach v ∈ C do
4   | cost(v) ← w(x) + ∑v' ∈ N(v) w(v')
5 end
6 while |C| > 1 and  $\frac{2 \cdot nb\_edges}{|C| \cdot (|C| - 1)} < 1.0$  do
7   | Select v* from V that minimizes cost(.)
8   | C ← C \ {v*}
9   | nb_edges ← nb_edges - |N(v*) ∩ C|
10  | foreach v ∈ {N(v*) ∩ C} do
11  |   | cost(v) ← cost(v) - w(v*)
12  |   end
13 end
14 Select a vertex v_random ∈ C
15 foreach v ∈ {N(v_random) \ C} do
16  |   if C ⊂ N(v) then
17  |     | C ← C ∪ {v}
18  |   end
19 end
```

tated to edges in G , resulting into graph G' , Fig. 2. It provides an exact value for the size of physical buffers that are allocated in the final executable. This is opposed to (Desnos et al., 2014), where the bound is a theoretical value that depends on the estimation of the internal working memory of DAGs' actors. Consequently, the MWC value in (Desnos et al., 2014) must be verified before being used to allocate physical memory.

4.4 Back-end

The back-end in Fig. 2 translates G' into a C program. Each actor (operation) in G' is translated into 4 implementation-specific C routines for initialization, execution, scheduling and clean-up purposes (Fig. 2). Initialization and clean-up routines are called once, when the program starts and terminates, respectively. These routines manipulate the software data structures that are needed by processing units in the target platform to prepare and clean up the execution of an actor in G' . Scheduling and execution routines are called to test the eligibility to run an op-

eration and to trigger its execution on the hardware, respectively. The memory bound determined by Algorithm 1 is used by the back-end to allocate shared physical buffers for operations mapped to the same execution unit.

In the current implementation of the compiler, these functions must be manually written by a user and are included in the final source executable code via a dedicated configuration file (.hal, hardware abstraction layer file in Fig. 2).

In our current implementation, the target C program schedules computations according to the availability of input data for operations (coherently to the SDF MoC). We did not implement a thread-based scheduler, as using threads and their synchronization mechanisms would lead to rigid executions that are difficult to scale in dynamic scenarios (Ousterhout, 1996; Dabek et al., 2002). For instance, in a system composed of multiple applications, in case one or more applications stops execution, it would be more difficult to re-synchronize its execution using threads (Lee, 2006).

4.5 Discussion

In this version of the model compiler, we did not include any environment for the analysis of the IRs' metamodels as this goes out of the scope of our current research interests. As described in (Floch et al., 2011), techniques such as generative approaches, model mapping, Domain Specific Languages and metamodel instrumentation exist to guarantee the correctness and maintainability of IR transformations. However, due to scalability reasons, their use is difficult to apply to research compilers. It is, however, a practically surmountable problem that can be solved by developing additional features to the model compiler. In the context of the case study of Section 5, we manually verified the equivalence between (i) the data-flow relations in graphs G, G' , (ii) the data-flow scheduling of operations in the target C program and (iii) the data-flow dependencies in the input PIM.

4.5.1 Portability

This implementation of the model compiler addresses platforms where the scheduling of operations is centrally executed by a single general-purpose control processor. The latter configures and dispatches the execution of operations to a set of physically distributed units (e.g., DSPs, DMAs, IPs), according to events generated upon the consumption/production of data by computation and communication operations. For each platform, a dedicated library of implementation-specific functions must be provided by re-using those

from other projects as templates. To target designs where the control code of an application is fragmented into separate executables that each run onto different CPUs, the compiler must be extended (e.g., produce multiple executables, include synchronization primitives among multiple units).

In order to use this implementation of the compiler with a design tool other than TTool/DIPLODOCUS, the user needs to write a new plug-in for the front-end. The existing plug-in can be used as a template to reduce development efforts.

4.5.2 Debugging

In the approach we propose in this paper, debugging is done at different locations: in the front-end MDE tool, in the C target program and the implementation-specific functions (e.g., *Valgrind*, *gdb*). In this implementation of the compiler, transformations of the Intermediate Representations can be manually debugged by comparing the data-flow relations among SDF actors in G , G' and those between SysML blocks in the input PIM. Also, simulation and formal verification techniques in the input MDE tool can be used to guarantee the correctness of the PIM and PSM with respect to design requirements.

5 CASE STUDY

We used the model compiler described in this paper to produce executable code for two target platforms, from the UML/SysML model of a 5G decoder that we designed in DIPLODOCUS for the uplink (SC-FDMA), single antenna case, Physical Uplink Shared channel (xPUSCH), based on (Verizon, 2015).

The algorithm of the signal-processing operations (**application**) that compose the 5G decoder is shown in Fig. 3. We captured this application in a TTool/DIPLODOCUS' PIM with a SysML Block Definition diagram containing 10 SysML Composite Components (1 source, 1 sink and 8 blocks, one for each of the signal-processing operations in Fig. 3). Each Composite Component contains 2 SysML Primitive Components that model the configuration and the data-processing of a given operation. By way of example, Fig. 4 shows the TTool/DIPLODOCUS SysML Composite and Activity diagrams for operation 64QAM Demodulation. Table 1 lists the data produced and consumed by operations in Fig. 3, given an input subframe (14 OFDM symbols and 41 LDPC code blocks). In our final implementations, the complex samples listed in Table 1 are represented

on 32 bits.

Table 1: Input/Output data of the decoder operations

Operation	Input	Output
Remove CP	30720 samples	2048 samples ¹
DFT	2048 samples ¹	2048 samples ¹
Sub-carrier demapping	2048 samples ¹	1200 samples ¹
IDFT	1200 samples ¹	1200 samples ¹
Demodulation	1200 resource elements ²	7200 soft bits ²
Descrambling	7200 soft bits ²	7200 soft bits ²
LDPC decoder	1944 soft bits ²	1620 hard bits ²
Code Block Concatenation	1620 hard bits ²	66416 hard bits ²
Remove CRC	66416 hard bits ²	66392 hard bits ²

In this case study we use two **target platforms**. One is **Embb** (Embb, 2017), a generic baseband architecture dedicated to signal-processing applications. Embb is composed of a Digital Signal Processing (DSP) part and a general purpose control part. The DSP part is composed of a set of Digital Signal Processing Units interconnected by a crossbar. Each DSP unit is equipped with a Processing Sub-System (PSS) as computational unit, a Direct Memory Access controller (DMA) and a local memory called the Memory Sub-System, MSS. These DSPU units can be seen as programmable IPs that are more flexible than traditional fully hard-wired accelerators. The general purpose control part is composed of a RAM memory and of a CPU that configures and controls the processing operations performed by the DSPUs and the data transfers.

The architecture of the second target platform, a hardware **IP-based platform** is composed of a programmable and of a configurable subsystem. The programmable subsystem executes control functions as well as signal-processing operations whose performance are not time critical. It is composed of a CPU and a RAM memory. The configurable subsystem accelerates performance-critical operations onto dedicated hardware IP blocks that can be selected by Xilinx SDx (Xilinx, 2017) from the target program produced by our compiler. An IP block includes a processing core, a local memory and a DMA engine, similarly to a DSPU in Embb.

Thanks to the similarities in the structure of the two target platforms, we captured their architecture in the UML Deployment diagram of TTool/DIPLODOCUS of Fig. 5. In Fig. 5, the left-hand part describes the

¹Per OFDM symbol

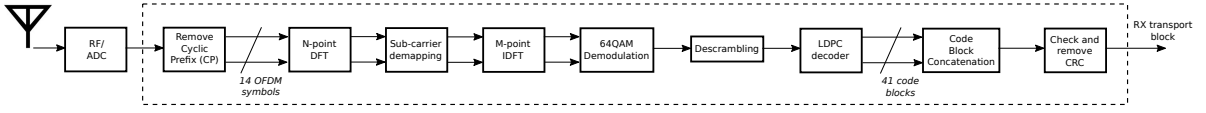

Figure 3: The block diagram of the 5G decoder designed in this case study (dotted line).

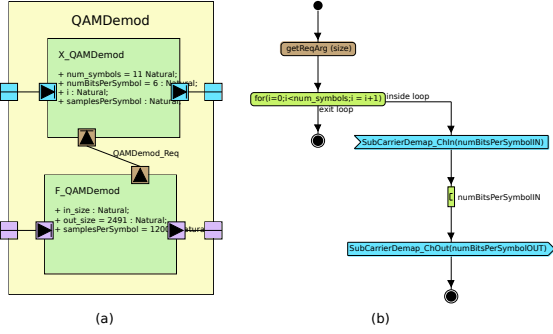

Figure 4: The SysML Composite (a) and Activity (b) diagrams for operation 64QAM Demodulation.

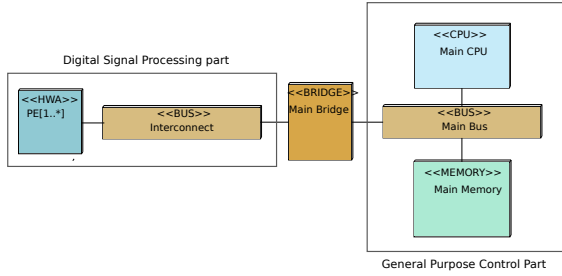

Figure 5: The UML Deployment Diagram of a generic instance of Embb and of the hardware IP-based platform.

subsystem where the processing of data is accelerated. Here, a PE (Processing Element) block models the architecture of a DSPU in Embb or a hardware IP block. The TTool/DIPLODOCUS model of a PE's internal architecture is depicted in Fig. 6. The right-hand side of Fig. 5 captures the control part of our two target platforms: a CPU and a memory units interconnected by a bus unit.

To compile executable code, we instantiated, in TTool/DIPLODOCUS, a PSM model such as the one in Fig. 5 that contains two Processing Elements for Embb and one Processing Element for the IP-based platform. The mapping information corresponding to these PSMs is illustrated in Fig. 7.

5.1 The model compilation

The optimization techniques used by our model compiler reduce the memory footprint by sharing the physical buffers among operations that are mapped

²Per frame

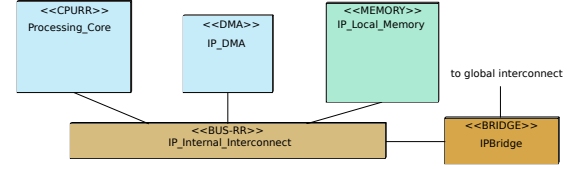

Figure 6: The UML Deployment Diagram for the generic architecture of a PE in Fig. 5.

to a given execution unit. In the case of Embb, according to the mapping in Fig. 7, each set of logical buffers $\{A_{out}, F_{in}^{F_{out}}, H_{in}, HI\}$, $\{B_{in}, BC, CD, DE, E_{out}\}$ and $\{G_{in}G_{out}\}$ in Fig. 7 is merged to share a common physical memory area. Given the sequential nature of the scheduling of these operations, the size of each of the three memory areas is equal to the size of the largest logical buffer: I_{in} , B_{in} and G_{out} . The target C program produced by the back-end is based on a library of 371 implementation-specific functions.

For the IP-based platform, according to the mapping in Fig. 7, the middle-end optimizes the memory footprint of two sets of logical buffers: $\{AB, BC, CD, DE, EF\}$ and $\{G_{in}G_{out}\}$ in Fig. 7. These two sets are merged and assigned a common memory area equal to the size of I_{in} and G_{in} , respectively. The back-end composes a target program by linking a library of 33 implementation-specific functions for each operation in Fig. 3.

5.2 The target program translation

In the case of Embb, the target C program is translated into an executable with GNU/gcc v.5.4.0 cross-compiled onto Ubuntu v.16.04.4. This executable (a pure software implementation of the input models) runs on the main CPU in Fig. 5 as a user-space application for Linux v.4.4.0-xilinx.

In the case of the IP-based platform, we translate the target C program with Xilinx SDx (Xilinx, 2017) into a mixed hardware-software implementation. The output of the Xilinx SDx translation process are a Linux image and an .elf file for the software part of the implementation, to be executed by the CPU of the programmable subsystem. The executable for the hardware part of the implementation is a FPGA bit-stream. The latter is loaded into the target FPGA's configurable fabric by a Linux image that runs onto

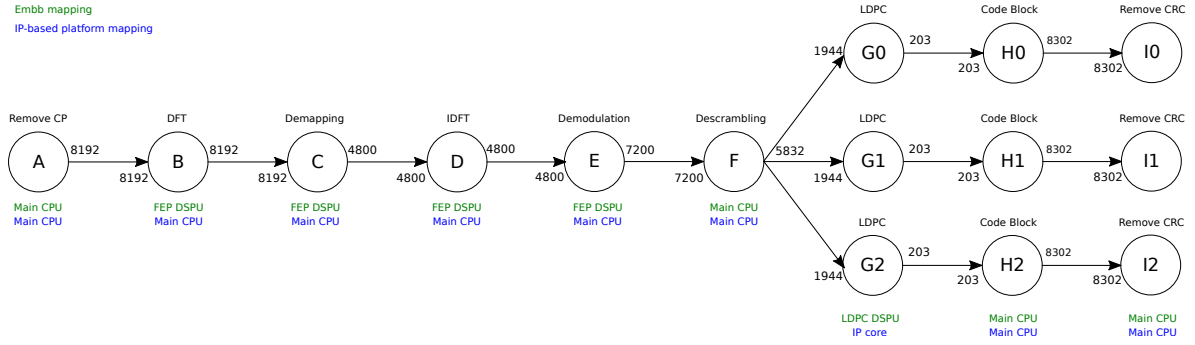

Figure 7: The single-rate SDF graph of the 5G decoder in Fig. 3 (tokens are expressed in bytes).

the FPGA’s control processor (not represented in our models).

5.3 Evaluation

In the case of Embb, the middle-end allocates 8192 and 1944 bytes to the local memories of the FEP and LDPC processors, respectively, as well as 8302 bytes to the main CPU memory. Assigning separate I/O FIFO buffers to each of the 5G decoder operations would have allocated 25984 bytes to the FEP local memory, 2147 bytes to the LDPC processor’s local memory and 39399 bytes to the main CPU memory. Compilation reduces the memory footprint of 68.47%, 9.46% and 78.93% for each of these three units, respectively. Overall, it reduces by 72.7% the memory used by the final executable code, with respect to pure translation-based approaches.

For the IP-based platform, the middle-end allocates 8302 bytes to the main CPU memory (programmable system) and 1944 bytes to the hardware IP-core memory (configurable system). A pure translation-based approach that allocates separate I/O FIFO buffers to each operation would have reserved 90375 bytes and 2147 bytes to the main CPU and the hardware IP-core memories, respectively. Our compilation achieves a memory footprint reduction equal to 90.81% and 9.46%, respectively, for these two units. Overall, this reduces by 88.93% the memory used in the mixed hardware-software implementation.

The middle-end of our compiler optimizes an application’s memory footprint by accounting for the mapping information of SDF actors onto a platform’s execution units. This scheduling update does not impact the overall **timing properties** of the final executable. Specifically to this 5G decoder, its real-time properties are limited by two factors. First, by the lack of parallelism between operations that is inherent to the application in Fig. 3. Secondly, by the absence in the

target platforms of multiple units capable to process different OFDM symbols in parallel. Because of the limited size of the FPGAs onto which we prototyped our platforms, it was only possible to instantiate one Front-End Processor unit and one LDPC processor in Embb as well as one hardware IP-block in the second platform. For instance, in Embb, the availability of only one FEP unit does not allow to pipeline the execution of operations DFT, Demapping, IDFT and Demodulation for consecutive OFDM symbols.

6 CONCLUSION

This paper proposes a compilation approach of system-level models for SoC implementations of signal-processing applications. With respect to the translation-based approaches discussed in Section 2, we showed that optimizing (compiling) the non-functional properties (i.e., memory footprint) of model-based specifications can result in significant performance improvement without impacts on the semantics of the system being modeled. In the domain of MDE for SoCs, we believe that this further reduces the gap between traditional programming approaches based on C/C++ and model-based *programming* techniques.

In future work, we will extend our case study with the complete design of an encoder chain. We will also consider the integration of other types of non-functional optimizations (e.g., to reduce power consumption).

ACKNOWLEDGEMENTS

The authors would like to thank Karol Desnos from INSA Rennes for his precious advice on data-flow MoCs and the memory reduction techniques (Desnos et al., 2014; Desnos et al., 2016).

REFERENCES

- Alf (2017). Action language for foundational uml (alf). <http://www.omg.org/spec/ALF/>.
- Apvrille, L. (2008). Ttool for diplodocus: An environment for design space exploration. In *NOTERE*, pages 28:1–28:4.
- Apvrille, L., Muhammad, W., Ameer-Boulifa, R., Coudert, S., and Pacalet, R. (2006). A uml-based environment for system design space exploration. In *ICECS*, pages 1272–1275.
- Bazydło, G., Adamski, M., and Stefanowicz, L. (2014). Translation uml diagrams into verilog. In *HSI*, pages 267–271.
- Ciccozzi, F., Cicchetti, A., and Sjodin, M. (2012). Full code generation from uml models for complex embedded systems. In *STEW*.
- Dabek, F., Zeldovich, N., Kaashoek, F., Mazieres, D., and Morris, R. (2002). Event-driven programming for robust software. In *SIGOPS*, pages 186–189.
- DaRTteam (2009). Graphical array specification for parallel and distributed computing (gaspard2). <http://www.gaspard2.org/>.
- Desnos, K., Pelcat, M., Nezan, J., and Aridhi, S. (2014). Memory analysis and optimized allocation of dataflow applications on shared-memory mpocs. *Journal of VLSI Signal Processing Systems for Signal, Image, and Video Technology*, pages 1–19.
- Desnos, K., Pelcat, M., Nezan, J., and Aridhi, S. (2016). On memory reuse between inputs and outputs of dataflow actors. *ACM Transactions on Embedded Computing Systems*, pages 30:1–30:25.
- Embb (2017). <http://embb.telecom-paristech.fr/>.
- Enrici, A., Apvrille, L., and Pacalet, R. (2017). A model-driven engineering methodology to design parallel and distributed embedded systems. *ACM TODAES*, 22(2):34:1–34:25.
- Fabri, J. (1979). *Automatic storage optimization*. Courant Institute of Mathematical Sciences, New York University.
- Floch, A., Yuki, T., Guy, C., Derrien, S., Combemale, B., Rajopadhye, S., and France, R. B. (2011). Model-driven engineering and optimizing compilers: A bridge too far? In *MODELS*, pages 608–622.
- fUML (2016). <http://www.omg.org/spec/FUML/1.2.1/>.
- Gamatie, A., Beux, S. L., Piel, E., Etien, A., Atitalah, R. B., Marquet, P., and Dekeyser, J. L. (2008). A model driven design framework for high performance embedded systems. <http://hal.inria.fr/inria-00311115/en>.
- Gerstlauer, A. and Gajski, D. D. (2002). System-level abstraction semantics. In *15th International Symposium on System Synthesis*, pages 231–236.
- Gerstlauer, A., Haubelt, C., Pimentel, A. D., Stefanov, T. P., Gajski, D. D., and Teich, J. (2009). Electronic system-level synthesis methodologies. *IEEE Transactions on Computer-Aided Design of Integrated Circuits and Systems*, 28(10):1517–1530.
- GNURadio (2017). Gnu radio. <http://gnuradio.org/>.
- Labview (2017). Labview communications system design. <http://www.ni.com/labview-communications/>.
- Lee, E. A. (2006). The problem with threads. Technical report, EECS Department, UC Berkeley.
- Lee, E. A. and Parks, T. M. (1995). Dataflow processes network. *Proceedings of the IEEE*, 83(5):1235–1245.
- Mathworks, T. (2017). <https://www.mathworks.com/solutions/model-based-design.html>.
- Mellor, S. J. and Balcer, L. (2002). *Executable UML: A Foundation for Model-Driven Architecture*. Addison Wesley.
- Mellor, S. J. and Balcer, M. J. (2003). Executable and translatable uml. http://www.omg.org/news/meetings/workshops/UML_2003_Manual/Tutorial4-Balcer.
- Mischkalla, F., He, D., and Mueller, W. (2010). Closing the gap between uml-based modeling, simulation and synthesis of combined hw/sw designs. In *DATE*, pages 1201–1206.
- Moreira, T. G., Wehrmeister, M. A., Pereira, C. E., Petin, G. F., and Levrat, E. (2010). Automatic code generation for embedded systems: From uml specifications to vhdl code. In *International Conference on Industrial Informatics*, pages 1085–1090.
- Nicolas, A., Penil, P., Posadas, H., and Villar, E. (2014). Automatic synthesis over multiple apis from uml/marte models for easy platform mapping and reuse. In *Euromicro DSD*, pages 443–450.
- Ousterhout, J. (1996). Why threads are a bad idea (for most purposes). <https://web.stanford.edu/~ouster/cgi-bin/papers/threads.pdf>.
- Schmidt, D. C. (2006). Model-driven engineering. *Computer*, 39(2):25–31.
- Tan, W. H., Thiagarajan, P. S., Wong, W. F., Zhu, Y., and Pilakkat, S. K. (2004). Synthesizable systemc code from uml models.
- Torczon, L. and Cooper, K. (2007). *Engineering a Compiler*. Morgan Kaufmann Publishers Inc., San Francisco, CA, USA, 2nd edition.
- Vanderperren, Y., Mueller, W., He, D., Mischkalla, F., and Dehaene, W. (2012). Extending uml for electronic systems design: A code generation perspective. In *Design Technology for Heterogeneous Embedded Systems*, pages 13–39.
- Verizon (2015). 5g specifications. <http://www.5gftf.org/>.
- Xi, C., JianHua, L., Zucheng, Z., and Yaohui, S. (2005). Modeling systemc design in uml and automatic code generation. In *ASP-DAC*, pages 932–935.
- Xilinx (2017). Sdx development environment. <https://www.xilinx.com/products/design-tools/all-programmable-abstractions.html>.